

# DEOMATIC

*Pièces détachées adaptables pour:*  
**ARISTARCO**



**DeoMatic Horeca-Industrie s.p.r.l.**  
Pièces détachées pour Cuisines Industrielles  
34 rue des alliés      Bongenotenstraat 34  
1190 Bruxelles      1190 Brussel

Tel. : 02 343 97 64  
Fax : 02 343 90 31  
deomatic@skynet.be  
www.deomatic.be

Partner of  **GEV GROUP**

**DEONLATIC**



Systèmes de lavage et de rinçage

**Page 4**



Divers et réservoirs d'air

**Page 9**

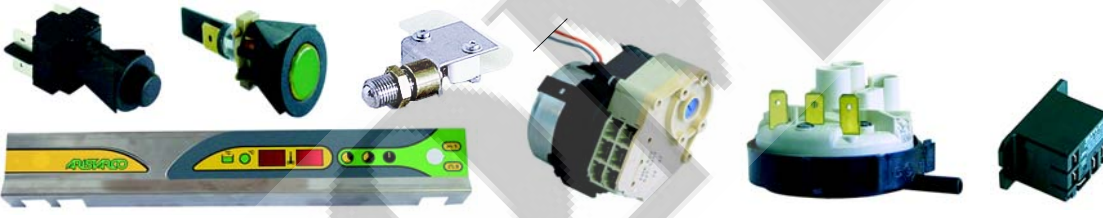

Systèmes de vidange et de filtre

**Page 10**

Mécanique de porte et de capot

**Page 13**

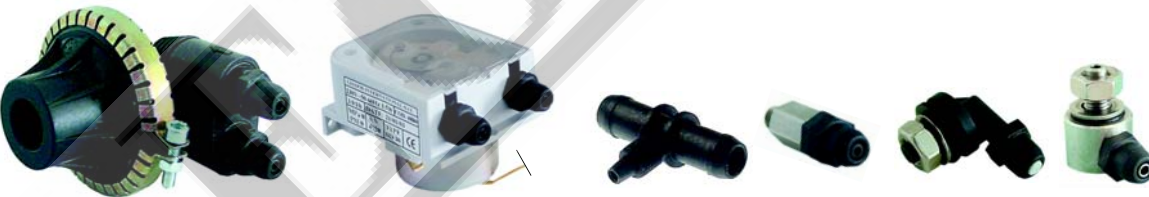
Composants électriques

**Page 14**

Technique de dosage

**Page 17**

Résistances et surchauffeurs

**Page 17**

Pompes et pièces de rechange

**Page 18**

## A Systèmes de lavage et de rinçage

Adaptables pour Aristarco

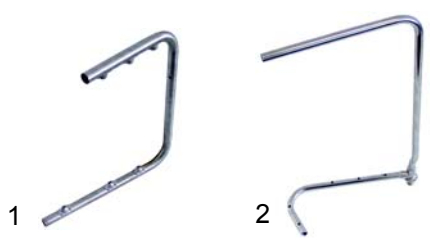

Fig.	Réf.	Description	Modèle	Réf. C.
1	508111	bras de lavage	Gemini CR,	2402
2	508075	bras de rinçage	Program 25CR	1795



Fig.	Réf.	Description	Modèle	Réf. C.
1	508063	bouchon de bras de lavage	Gemini CR, Program 25CR	1692
2	508056	bouchon de bras de rinçage		1223
3	508078	joint torique		1826



Fig.	Réf.	Description	Modèle	Réf. C.
1	508017	joint		124
2	508361	écrou de fixation bras de rinçage	Gemini CR, Program 25CR	125
3	508051	olive		1183
4	508052	raccord olive		1184



Fig.	Réf.	Description	Modèle	Réf. C.
1	508253	gicleur rinçage	Gemini CR, Program 25CR	4359
2	508079	gicleur lavage complet		1832

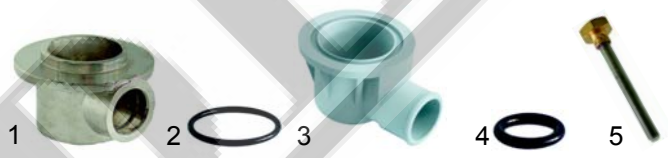

Fig.	Réf.	Description	Modèle	Réf. C.
1	508076	collecteur		1796
2	508061	joint torique		1633
3	508064	pipe alimentation	Gemini CR, Program 25CR	1695
4	508016	joint torique		123
5	508077	vis		1797

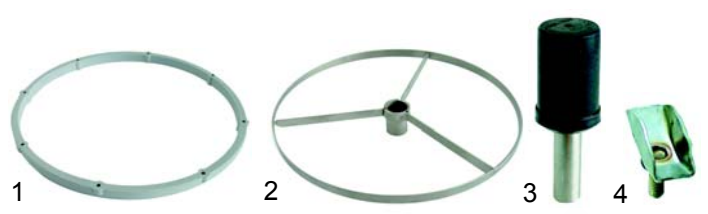

Fig.	Réf.	Description	Modèle	Réf. C.
1	508042	support panier		631
2	508341	support de panier rond	Gemini CR, Program 25CR	179011
3	508073	axe de support de panier rond complet		1724
4	508020	goujon fixation		157

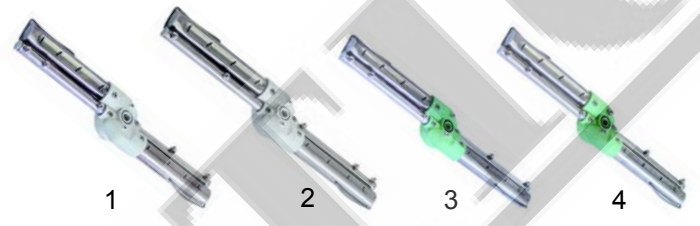

Fig.	Réf.	Description	Modèle	Réf. C.
1	508242	bras de lavage en bas	Passport 35.21	4132
2	508244	bras de lavage en bas/ en haut	Passport 38.25 Passport 40.28 Compact 20 Master 22	4160
3	508299	bras de lavage en haut	Aliseo 422, 428	5010
4	508296	bras de lavage en bas	Aliseo 422, 428	4986

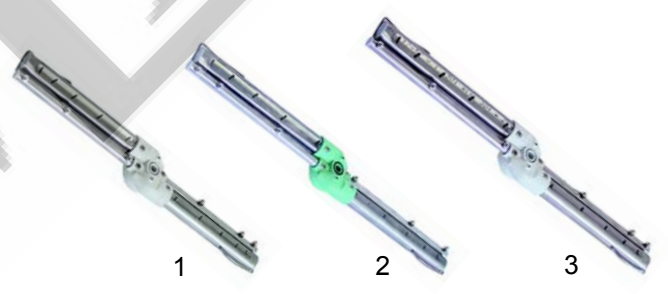

Fig.	Réf.	Description	Modèle	Réf. C.
1	508245	bras de lavage en haut/en bas	Passport 45.30	4162
2	508247	bras de lavage en haut/ en bas (verres)	Passport 50.30	4164
3	508246	bras de lavage en haut/ en bas (assiettes)	Passport 50.30	4163

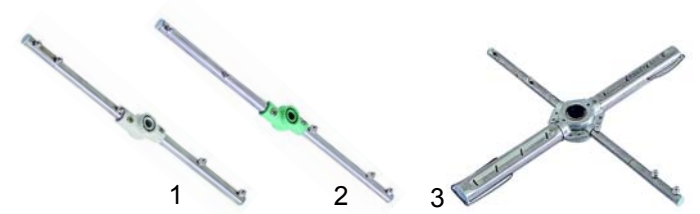

Fig.	Réf.	Description	Modèle	Réf. C.
1	508243	bras de rinçage complet	Passport 35.21, Compact 20, Master 22	4133
2	508255	bras de rinçage complet	Gemini CF, Program 25 CF, Master21, Minibar CF	4376 1712
3	508265	bras de lavage en bas	Gemini CF, Program 25CF, Master21, Minibar CF, Project 28	4724 2762

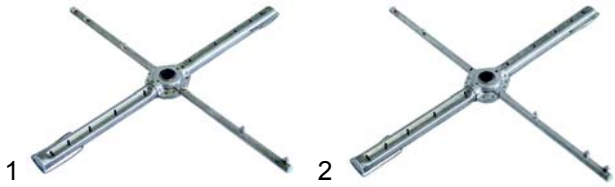

Fig.	Réf.	Description	Modèle	Réf. C.
1	508212	bras de lavage en haut/en bas	AL50.34E (assiettes)	3048 4720
2	508211	bras de lavage en haut/en bas	AL50.34E (verres)	3021 5051

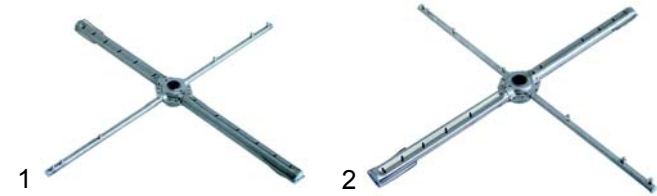

Fig.	Réf.	Description	Modèle	Réf. C.
1	508216	bras de lavage en haut/en bas	Passport 55.40 Passport 10.40	3087 4841
2	508323	bras de lavage en haut/en bas	AL 55.45E	6471 6472

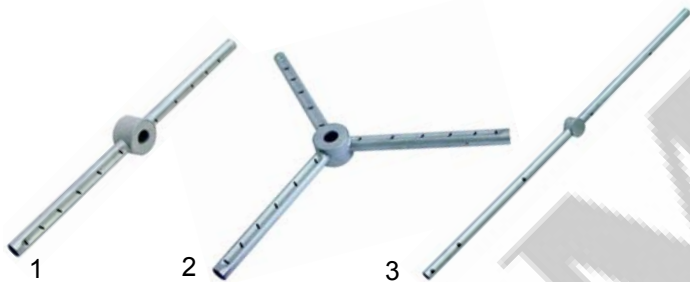

Fig.	Réf.	Description	Modèle	Réf. C.
1	508172	bras de lavage (assiettes)	GL1040	2757
1	508174	bras de lavage (verres)	GL1040	2759
2	508173	bras de lavage (assiettes)	GL1240	2758
2	508175	bras de lavage (verres)	GL1240	2760
3	508177	bras de rinçage	GL1040, GL1240	2761



Fig.	Réf.	Description	Modèle	Réf. C.
1	508112	écrou plat	GL1040, GL1240	2416
2	508114	douille	GL1040, GL1240	2414
3	508113	bras rinçage inox	GL1040, GL1240	2417



Fig.	Réf.	Description	Modèle	Réf. C.
1	508008	joint torique bras de lavage		93
2	508145	bouchon de bras de lavage		2650
3	508146	ressort	universel	2654
4	508125	joint torique bras de rinçage		2531
5	508122	bouchon de bras de rinçage		2502
6	508253	gicleur rinçage		4359
6	508062	gicleur rinçage (ancien)		1669



Fig.	Réf.	Description	Modèle	Réf. C.
1	508115	douille de bras de lavage	GL1040, GL1240	2445
2	508104	douille de bras de lavage	universel	2265
3	508047	vis fixation bras	universel	1133, 4374



Fig.	Réf.	Description	Modèle	Réf. C.
1	508082	partie centrale tourniquet lavage		1954
2	508083	partie centrale tourniquet rinçage		1955

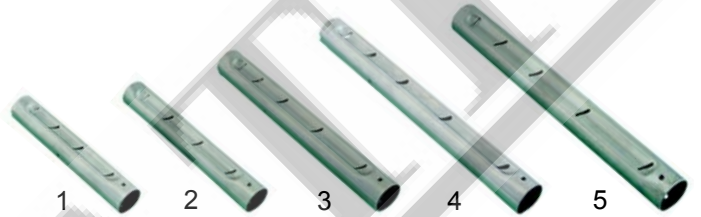

Fig.	Réf.	Description	Modèle	Réf. C.
1	508227	bras de lavage 137mm		3195
2	508230	bras de lavage 157mm		3198
3	508234	bras de lavage 192mm		4001
4	508238	bras de lavage 217mm (assiettes)		4005
5	508237	bras de lavage 217mm (verres)		4004

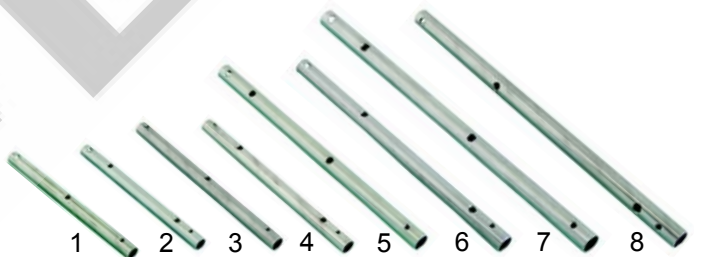

Fig.	Réf.	Description	Modèle	Réf. C.
1	508228	bras de rinçage 150mm (2 gicleurs)		3196
2	508229	bras de rinçage 150mm (3 gicleurs)		3197
3	508231	bras de rinçage 170mm (2 gicleurs)		3199
4	508233	bras de rinçage 170mm (3 gicleurs)		4000
5	508235	bras de rinçage 205mm (3 gicleurs)		4002
6	508236	bras de rinçage 205mm (3 gicleurs)		4003
7	508239	bras de rinçage 232mm (3 gicleurs)		4006
8	508240	bras de rinçage 232mm (3 gicleurs)		4007



Fig.	Réf.	Description	Modèle	Réf. C.
1	508033	gicleur lavage complet intérieur (assiettes)	GL500CF/CR GL700 CF/CR	213
2	508034	gicleur lavage complet extérieur (assiettes)		214
3	508013	gicleur lavage complet intérieur (verres)	GL500 CF	111
4	508053	gicleur lavage complet extérieur (verres)	GL 700 CF	1186



Fig.	Réf.	Description	Modèle	Réf. C.
1	508079	gicleur lavage complet	Gemini CR (ancien),	1832
2	508062	gicleur rinçage	Program 25CR (ancien), Minibar ( )	1669



Fig.	Réf.	Description	Modèle	Réf. C.
1	508183	collecteur rinçage		2797
2	508008	joint torique	Passport 35.21, Master 21, 22	93
3	508181	axe de bras de rinçage		2790
4	508048	collecteur rinçage	Compact 20, Gemini CF, Program 25CF	1171



Fig.	Réf.	Description	Modèle	Réf. C.
1	508049	rondelle téflon		1173
2	508096	axe de bras de rinçage		2153
3	508257	rondelle entretoise		4671
4	508219	bras rinçage inox	Passport 35.21	3155
5	508258	capot		4672
6	508061	joint torique		1633
7	508064	collecteur en bas		1695

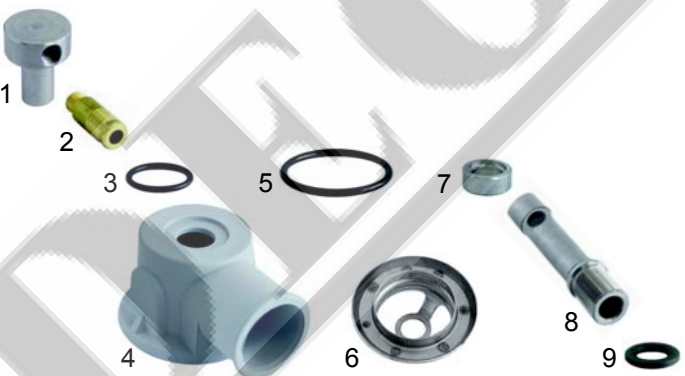

Fig.	Réf.	Description	Modèle	Réf. C.
1	508120	raccordement de rinçage		2482
2	508119	raccord tuyau	Passport 38.25, Passport 40.28,	2481
3	508001	joint torique	Passport 45.30,	25
4	508095	raccord de lavage	Passport 50.32,	2150
5	508061	joint torique	Passport 50.35,	1633
6	508178	rondelle (conique)	Passport 55.40,	2763
7	508167	rondelle entretoise	Project p28.E/EM, GL 4.32E/EM,	2733
8	508096	axe de bras de rinçage	AL 55.45E/P	2153
9	508049	rondelle téflon		1173



Fig.	Réf.	Description	Modèle	Réf. C.
1	508120	raccordement de rinçage		2482
2	508119	raccord tuyau		2481
3	508001	joint torique		25
4	508095	raccord de lavage	Aliseo 422, Aliseo 428	2150
5	508303	rondelle entretoise conique		5113
6	508061	joint torique		1633
7	508257	entretoise		4671
8	508302	axe de bras de rinçage		5110
9	508049	rondelle téflon		1173



Fig.	Réf.	Description	Modèle	Réf. C.
1	508120	raccordement de rinçage		2482
2	508164	raccord tuyau		2730
3	508008	joint torique		93
4	508143	entretoise		2594
5	508161	joint torique		2713
6	508142	flasque	GL 1040, GL 1240	2593
7	508109	joint torique		2374
8	508158	capot		2710
9	508089	rondelle téflon		2130
10	508156	bras rinçage inox		2708
11	508197	rondelle		2914
12	508141	axe de bras de rinçage		2587



Fig.	Réf.	Description	Modèle	Réf. C.
1	508286	raccordement de rinçage		4923
2	508119	raccord tuyau		2481
3	508001	joint		25
4	508095	collecteur en haut		2150
5	508061	joint	Passport 1040	1633
6	508287	capot		4925
7	508289	bras rinçage inox		4927
8	508162	rondelle		2718
9	508096	axe de bras de rinçage		2153
10	508049	rondelle téflon		1173



Fig.	Réf.	Description	Modèle	Réf. C.
1	508049	rondelle téflon		1173
2	508096	axe de bras de rinçage		2153
3	508257	entretoise		4671
4	508220	bras rinçage inox		3156
5	508258	capot	Passport 38.25, Passport 40.28	4672
6	508061	joint torique		1633
7	508094	collecteur en bas		2149
8	508001	joint		25
9	508180	raccordement de rinçage		2789
10	508119	raccord tuyau		2481

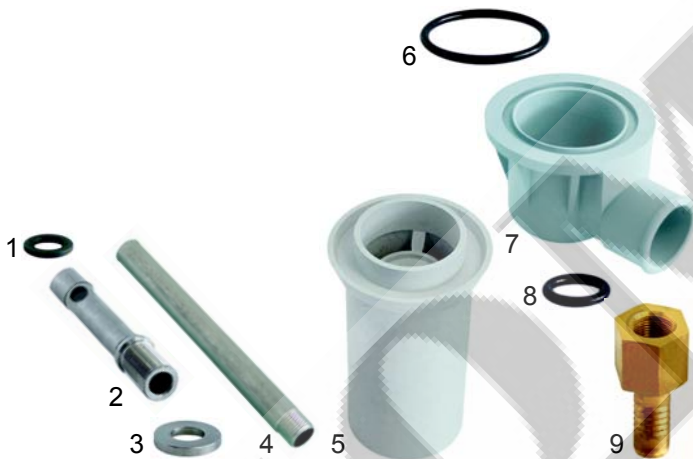

Fig.	Réf.	Description	Modèle	Réf. C.
1	508049	rondelle téflon		1173
2	508096	axe de bras de rinçage		2153
3	508257	entretoise		4671
4	508219	bras rinçage inox		3155
5	508258	capot	Passport 35.21	4672
6	508061	joint torique		1633
7	508064	collecteur en bas		1695
8	508016	joint torique		123
9	508179	raccord tuyau		2788

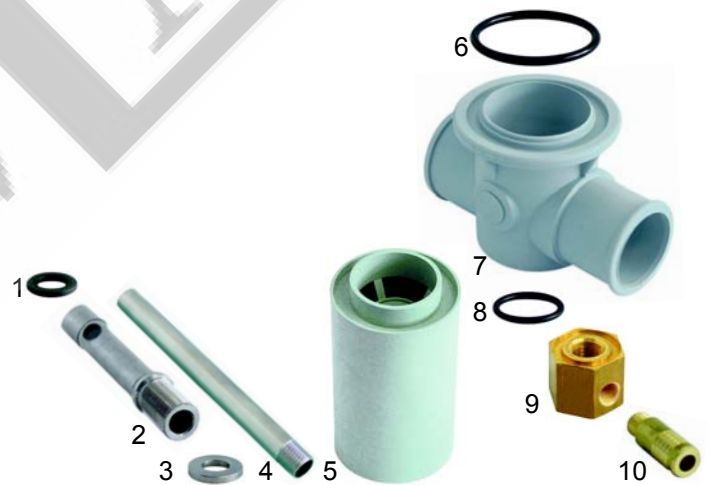

Fig.	Réf.	Description	Modèle	Réf. C.
1	508049	rondelle téflon		1173
2	508096	axe de bras de rinçage		2153
3	508257	entretoise		4671
4	508097	bras rinçage inox		2154
5	508259	capot	Passport 45.30	4673
6	508061	joint torique		1633
7	508094	collecteur en bas		2149
8	508001	joint		25
9	508180	raccordement de rinçage		2789
10	508119	raccord tuyau		2481



Fig.	Réf.	Description	Modèle	Réf. C.
1	508049	rondelle téflon	Passport 50.32 Passport 50.35	1173
2	508096	axe de bras de rinçage		2153
3	508257	entretoise		4671
4	508206	bras rinçage inox		2991
5	508260	capot		4674
6	508061	joint torique		1633
7	508094	collecteur en bas		2149
8	508001	joint		25
9	508180	raccordement de rinçage		2789
10	508119	raccord tuyau		2481



Fig.	Réf.	Description	Modèle	Réf. C.
1	508049	rondelle téflon	Passport 1040	1173
2	508096	axe de bras de rinçage		2153
3	508162	entretoise		2718
4	508288	bras rinçage inox		4926
5	508285	capot		4920
6	508061	joint torique		1633
7	508094	collecteur en bas		2149
8	508001	joint		25
9	508180	raccordement de rinçage		2789
10	508119	raccord tuyau		2481



Fig.	Réf.	Description	Modèle	Réf. C.
1	508049	rondelle téflon	Passport 50.40 GL5.34, GL7.38	1173
2	508096	axe de bras de rinçage		2153
3	508162	entretoise		2718
4	508206	bras rinçage inox		2991
5	508208	capot		2993
6	508061	joint torique		1633
7	508094	collecteur en bas		2149
8	508001	joint		25
9	508180	raccordement de rinçage		2789
10	508119	raccord tuyau		2481



Fig.	Réf.	Description	Modèle	Réf. C.
1	508049	rondelle téflon	Compact 20, Mas- ter 21, Master 22, Gemini CF, Program 25CF, Minibar CF	1173
2	508066	axe de bras de rinçage		1697
3	508167	entretoise		2733
4	508178	rondelle entretoise conique		2763
5	508061	joint torique		1633
6	508064	collecteur en bas		1695
7	508016	joint torique		123
8	508106	raccordement de rinçage		2294
9	508179	raccordement de rinçage		2788



Fig.	Réf.	Description	Modèle	Réf. C.
1	508049	rondelle téflon	Project 28E/EM, GL4.32E/EM	1173
2	508096	axe de bras de rinçage		2153
3	508162	entretoise		2718
4	508097	bras rinçage inox		2154
5	508192	capot		2870
6	508061	joint torique		1633
7	508094	collecteur en bas		2149



Fig.	Réf.	Description	Modèle	Réf. C.
1	508049	rondelle téflon	AL50.34E, AL50.40E	1173
2	508096	axe de bras de rinçage		2153
3	508162	entretoise		2718
4	508316	bras rinçage inox		6391
5	508317	capot		6392
6	508061	joint torique		1633
7	508094	collecteur en bas		2149





Fig.	Réf.	Description	Modèle	Réf. C.
1	508089	rondelle téflon		2130
2	508141	bras rinçage inox		2587
3	508197	rondelle		2914
4	508157	capot		2709
5	508109	joint torique	GL1040,	2374
6	508142	flasque	GL1240	2593
7	508161	joint torique		2713
8	508155	bras rinçage inox		2707
9	508148	joint torique		2662
10	508001	joint		25
11	508199	raccord tuyau		2921

## Divers



Fig.	Réf.	Description	Modèle	Réf. C.
1	508241	4 voies-accouplement (1 voie fermée)		4120, 4807 4808, 4810 4941, 4943 4938, 4942 2793, 2911
2	508123	té doseur		2503
3	508116	raccord olive		2450

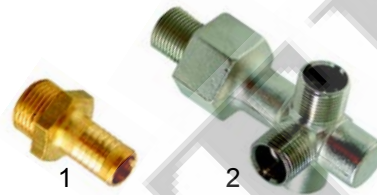

Fig.	Réf.	Description	Modèle	Réf. C.
1	508060	raccord tuyau 3/8"-12		1387
2	508344	répartiteur		214711



Fig.	Réf.	Description	Modèle	Réf. C.
1	508049	rondelle téflon		1173
2	508302	axe de bras de rinçage		5110
3	508257	rondelle		4671
4	508277	bras rinçage inox	Aliseo 422,	4756
5	508304	capot	Aliseo 428	5114
6	508061	joint torique		1633
7	508094	collecteur en bas		2149
8	508118	durite de refoulement		2480
9	508278	réduction		4760

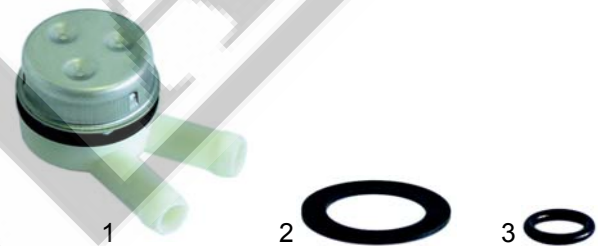

Fig.	Réf.	Description	Modèle	Réf. C.
1	516101	clapet anti vide		2376, 4731, 4732, 4735, 2802, 4804, 4733, 4734, 4070
2	508215	joint extérieur		3086
3	508016	joint intérieur		123

## Réservoirs d'air

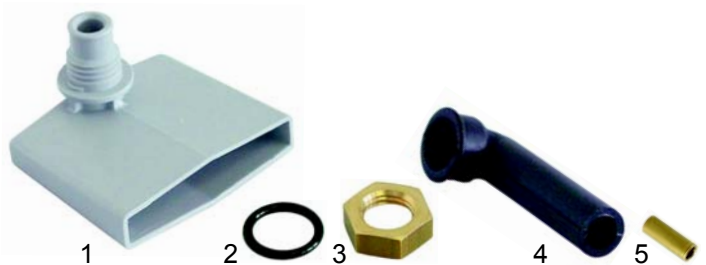

Fig.	Réf.	Description	Modèle	Réf. C.
1	508202	réservoir air		2932
2	508204	joint		2934
3	508200	écrou		2924
4	508201	coude de tuyau		2927
5	508203	tube renforcé		2933



Fig.	Réf.	Description	Modèle	Réf. C.
1	508096	axe de bras de rinçage		2153
2	508162	rondelle		2718
3	508252	bras rinçage inox	AL 55.45E, AL 55.45E/P	4218
4	508251	capot		4217
5	508061	joint torique		1633
6	508094	collecteur en bas		2149



Fig.	Réf.	Description	Modèle	Réf. C.
1	508030	réservoir air	Program 25CF/CR, Minibar CF/CR	206
2	508059	réservoir air	Master 21, GL500-700	1349
3	508031	joint		207
4	520231	écrou M10x1		267



Fig.	Réf.	Description	Modèle	Réf. C.
1	508103	surverse trop plein	Compact 20, Master 21, 22,	2199
2	508012	bonde de vidange	Minibar CF/CR,	110
3	508011	joint	Gemini CF/CR,	109
4	508010	coude de vidange	Program 25CF/CR, Aliseo 422/428	108

## Systèmes de vidange et de filtre

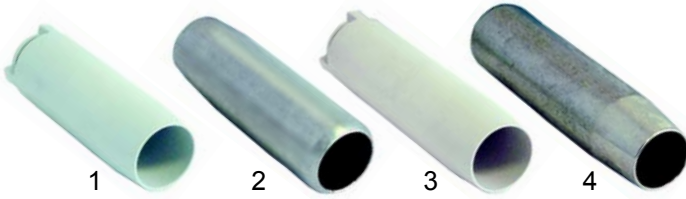

Fig.	Réf.	Description	Modèle	Réf. C.
1	508249	surverse trop plein	Passport 35.21/ 38.25/	4183
2	508105	surverse trop plein inox	40.28/ 45.30, Project 28, GL4.32, GL534, GL738	2274
3	508250	surverse trop plein	Passport 50.32/ 50.35	4184
4	508207	surverse trop plein inox		2992

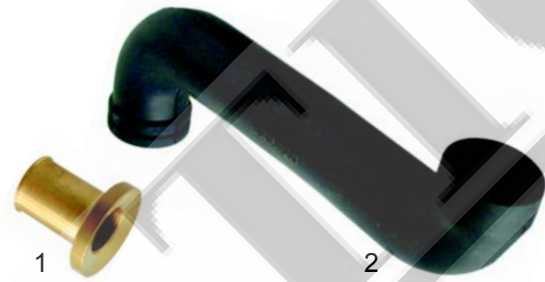

Fig.	Réf.	Description	Modèle	Réf. C.
1	508117	bonde de vidange/ support en bas	Program 25CF Compact 20	2478
2	508022	tuyau profilé en caoutchouc		161



Fig.	Réf.	Description	Modèle	Réf. C.
1	508305	surverse trop plein	Passport 55.40	5669
2	508152	surverse trop plein	Passport 1040, GL1040, GL1240	2704
3	508333	surverse trop plein	AL 50.34E, AL 50.40E	9070
4	508336	surverse trop plein	AL 55.45	9113



Fig.	Réf.	Description	Modèle	Réf. C.
1	508309	filtre de cuve	Passport 45.30	6279
2	508308	filtre de cuve	Passport 50.30/ 50.35	6278
3	508310	filtre de cuve	Passport 50.40	6280

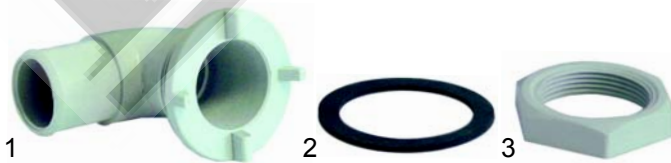

Fig.	Réf.	Description	Modèle	Réf. C.
1	508002	bonde de vidange		32
2	508029	joint		204
3	508028	écrou		203



Fig.	Réf.	Description	Modèle	Réf. C.
1	508318	filtre de cuve	AL 50.34E, AL 50.40E	6398
2	508319	filtre de cuve	AL 55.45E	6434



Fig.	Réf.	Description	Modèle	Réf. C.
1	508217	filtre d'aspiration	Passport 35.21/ 38.25/ 40.28	3113
2	508226	tamis décurage		3169
3	508263	filtre d'aspiration (assiettes)	Passport 45.30/ 50.32/ 50.35/ 55.40/ 1040, Project 28, GL4.32, GL1040, GL1240	4721 43
4	508264	filtre d'aspiration (verres)	Passport 50.32, Project 28, GL432	4722 114

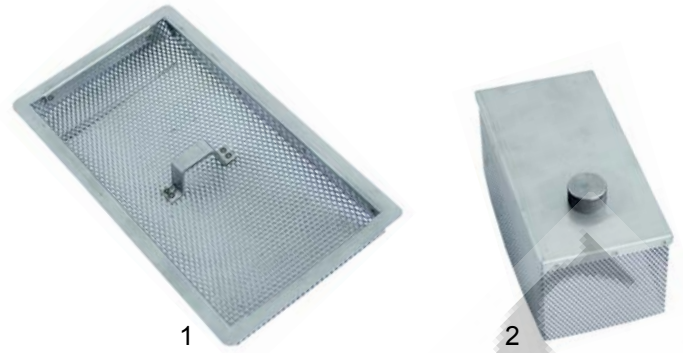

Fig.	Réf.	Description	Modèle	Réf. C.
1	508297	filtre	Aliseo 422, 428	4995
2	508293	filtre d'aspiration		4954

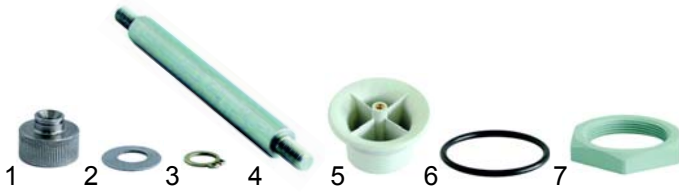

Fig.	Réf.	Description	Modèle	Réf. C.
1	508194	écrou plat	Passport 45.30, 50.32,	2901
2	508195	rondelle	50.35, 55.40, 1040,	2904
3	508014	clips	Project 28, GL4.32,	113
4	508193	tige fixation	GL1040, GL1240	2900
5	508108	bonde de vidange	Passport 45.30, 50.32,	2373
6	508109	joint torique	50.35, 55.40, 1040,	2374
7	508107	écrou	Project 28, GL4.32	2362

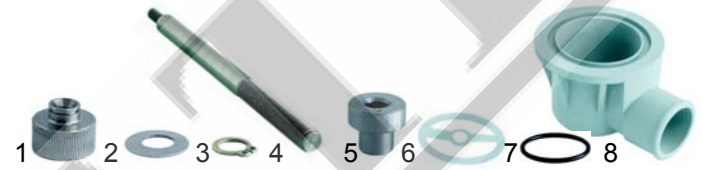

Fig.	Réf.	Description	Modèle	Réf. C.
1	508194	écrou plat		2901
2	508195	rondelle		2904
3	508014	clips		113
4	508292	tige fixation	Aliseo	4953
5	508291	vis	422, 428	4948
6	508329	bonde de vidange tête robinet		7990
7	508061	joint		1633
8	508064	soupape d'aspiration support en bas		1695

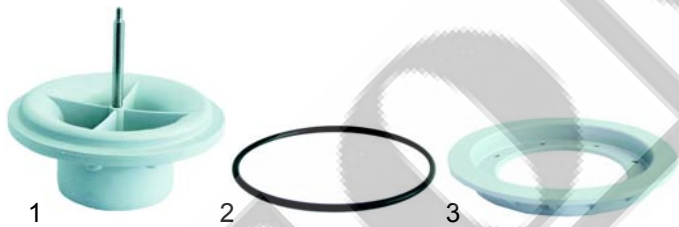

Fig.	Réf.	Description	Modèle	Réf. C.
1	508081	bonde de vidange		1933
2	508129	joint		2564
3	508126	raccord d'aspiration		2541

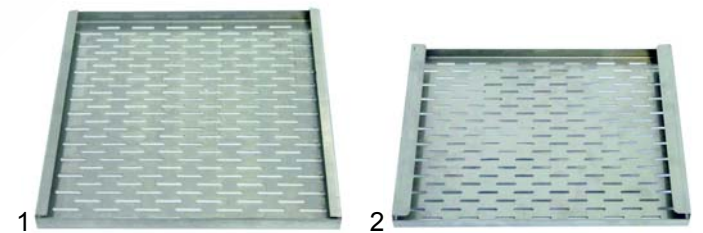

Fig.	Réf.	Description	Modèle	Réf. C.
1	508331	filtre	Passport 55.40	8857
2	508150	filtre	Passport 1040, GL1040, GL1240	2701

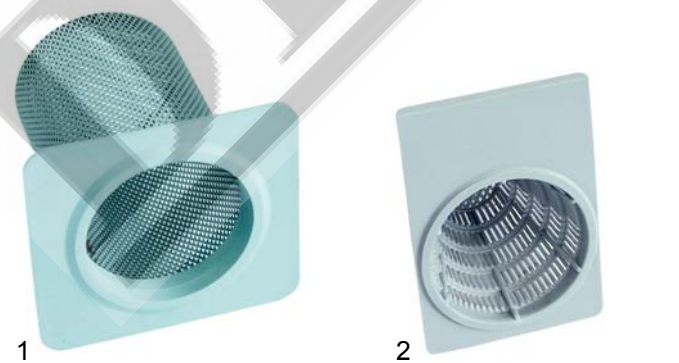

Fig.	Réf.	Description	Modèle	Réf. C.
1	508050	filtre d'aspiration	Gemini CF/CR	1177
2	508018	filtre d'aspiration	Compact 20	137

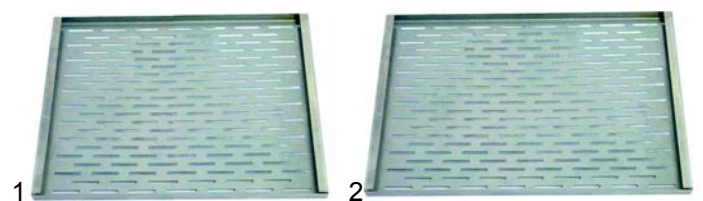

Fig.	Réf.	Description	Modèle	Réf. C.
1	508311	filtre	AL50.34E AL50.40E	6341
2	508335	filtre	AL55.45E	9105

## A Durites d'aspiration et de refoulement

Adaptables pour Aristarco

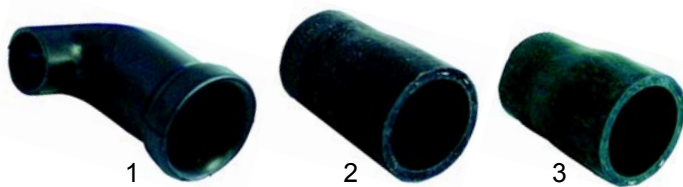

Fig.	Réf.	Description	Modèle	Réf. C.
1	508214	durite d'aspiration	Passport 35.21, 38.25, 40.28	3080
2	508092	durite de refoulement	Passport 35.21	2139
3	508248	durite de refoulement	Passport 38.25, 40.28	4171

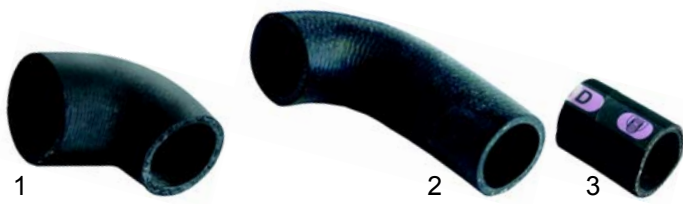

Fig.	Réf.	Description	Modèle	Réf. C.
1	508147	durite d'aspiration	Passport 45.30, 50.32, 50.35, 50.40, 1040, GL4.32	2655
2	508205	durite de refoulement	Passport 45.30, 50.32, 50.35, 50.40, GL4.32	2962
3	508290	durite de refoulement	Passport 1040	4935

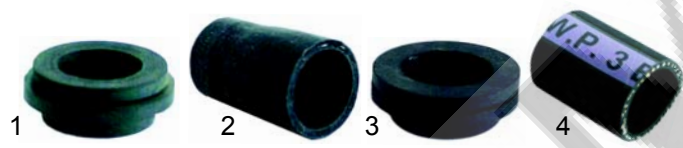

Fig.	Réf.	Description	Modèle	Réf. C.
1	508093	bague d'étanchéité	Compact 20, Master	2140
2	508092	durite de refoulement	Compact 20, Master	2139
3	508046	bague d'étanchéité	Gemini CF, Program 25	706
4	508045	durite de refoulement	CF/LR	700



Fig.	Réf.	Description	Modèle	Réf. C.
1	508147	durite d'aspiration	Project 28E	2655
2	508099	durite de refoulement	Project 28E	2157



Fig.	Réf.	Description	Modèle	Réf. C.
1	508325	durite d'aspiration	AL 55.45E/P	6534
2	508327	durite d'aspiration	AL 50.34E, AL 50.40E	6544
3	508205	durite de refoulement	AL 50.34, AL50.40E, AL 55.45E/P	2962



Fig.	Réf.	Description	Modèle	Réf. C.
1	508128	durite d'aspiration	GL1040,	2549
2	508166	durite de refoulement	GL1240	2732



Fig.	Réf.	Description	Modèle	Réf. C.
1	508295	durite d'aspiration	Aliseo 422, 428	4985
2	508294	durite de refoulement	Aliseo 422, 428	4984

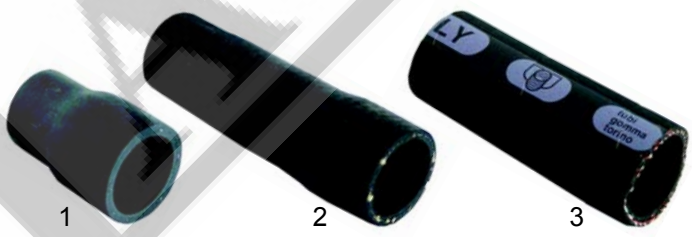

Fig.	Réf.	Description	Modèle	Réf. C.
1	508118	durite de refoulement en haut	Passport 38.25, Passport 40.28, Passport 45.30	2480
2	508213	durite de refoulement en haut	Passport 50.32, Passport 50.35, Passport 55.40, Passport 1040	3072
3	508165	durite de refoulement en haut	GL 1040 (ancien), GL1240 (ancien)	2731

## Mécanisme de porte



Fig.	Réf.	Description	Modèle	Réf. C.
1	508275	tirant porte	Passport 35.21,	4744
2	508223	douille	Passport 38.25,	3165
3	508222	écrou	Passport 40.28,	3164
4	508362	Tropfensammler	Passport 45.30,	4438
5	508198	embout loqueteau	Passport 50.32,	2919
6	508256	rondelle-butée	Project 28E/EM,	4609
7	508225	vis charnière	GL4.32, Aliseo 422/428	3167

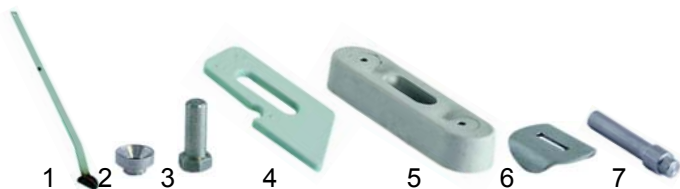

Fig.	Réf.	Description	Modèle	Réf. C.
1	508276	tirant porte	Passport 55.40	4745
2	508223	douille		3165
3	508224	goupille		3166
4	508362	égouttoir		4438
5	508198	embout loqueteau		2919
6	508256	rondelle-butée		4609
7	508225	vis charnière		3167



Fig.	Réf.	Description	Modèle	Réf. C.
1	508072	support pour ressort	Compact 20, Gemini CF/CR, Minibar CF/CR	1723
2	508071	ressort		1722
3	508124	support pour ressort		2508
4	508070	tige porte		1715
5	508069	tige porte		Compact 20, Gemini CF/CR, Minibar CF/CR, Master 21/22, Program CF/CR



Fig.	Réf.	Description	Modèle	Réf. C.
1	508313	boulon de porte droit	AL 50.34E, AL 50.40E, AL 55.45E/EP	6370
2	508314	boulon de porte gauche		6371
3	508321	joint torique		6456
4	508315	ressort		6377
5	508324	égouttoir		6473



Fig.	Réf.	Description	Modèle	Réf. C.
1	508102	fermeture complet		2194
2	508360	écrou		897
3	508057	embout		1272
4	508339	capuchon droit		126011
5	508338	capuchon gauche		126010



Fig.	Réf.	Description	Modèle	Réf. C.
1	508307	caoutchouc autocollant 15x4mm		6143

## Mécanique de capot



Fig.	Réf.	Description	Modèle	Réf. C.
1	508153	poignée	Passport 1040, GL 1040, GL 1240	2705
2	508154	arbre		2706
3	508127	ressort		2543

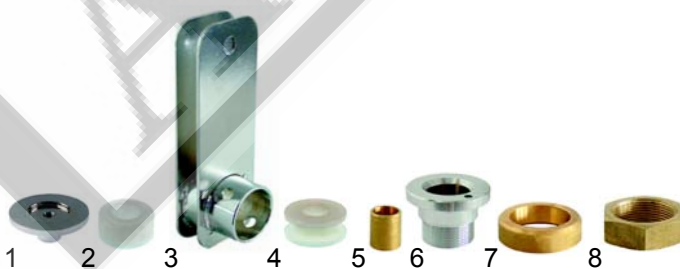

Fig.	Réf.	Description	Modèle	Réf. C.
1	508132	rondelle de fixation		2577
2	508139	bague de garniture		2585
3	508159	support pour ressort		2711, 2712, 2832
4	508131	rondelle élastique	Passport 1040, GL 1040, GL 1240	2576
5	508130	tube d'écartement pour roulette		2574
6	508140	manchon de raccordement arbre		2586
7	508135	rondelle entretoise		2580
8	508136	écrou M32x1,5		2581

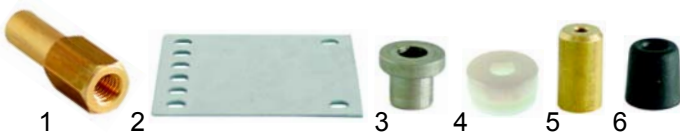

Fig.	Réf.	Description	Modèle	Réf. C.
1	508137	rallonge micro-rupteur		2582
2	508168	Federhalter en bas		2738
3	508134	douille	Passport 1040, GL 1040,	2579
4	508133	turbine	GL 1240	2578
5	508138	butée		2583
6	508041	capuchon		626

## A Composants électriques

Adaptables pour Aristarco

### Bandeaux

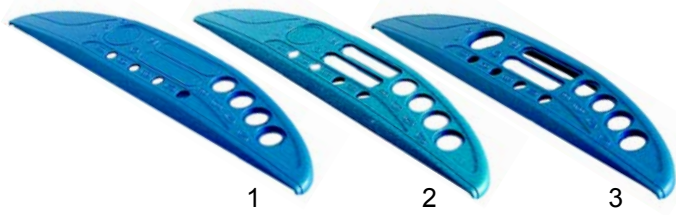

Fig.	Réf.	Description	Modèle	Réf. C.
1	508349	diaphragme	Passport 35.21, Passport 38.25, Passport 40.28	6201
2	508350	diaphragme	Passport 45.30, Passport 50.32, Passport 50.35, Passport 1040	6202
3	508351	diaphragme	Passport 55.40	6203

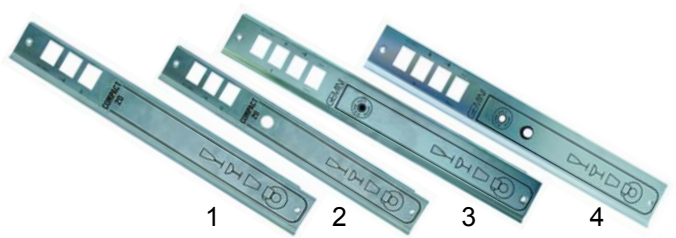

Fig.	Réf.	Description	Modèle	Réf. C.
1	508347	diaphragme	Compact 20	2464
2	508346	diaphragme (pompe de vidange)		2805
3	508363	diaphragme	Gemini	1688
4	508364	diaphragme (pompe de vidange)		1369

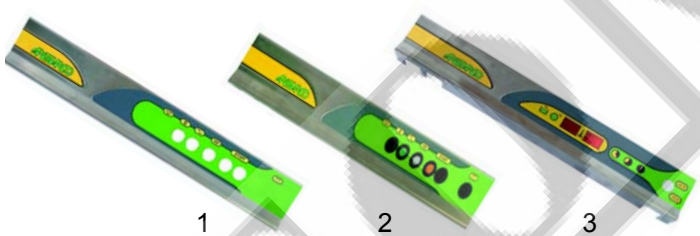

Fig.	Réf.	Description	Modèle	Réf. C.
1	508365	panneau de commande	Program 25CF/LR	8385
2	508357	panneau de commande	Project 28EM, Aliseo 422/428	5000
3	508366	panneau de commande	Project 28E	4248

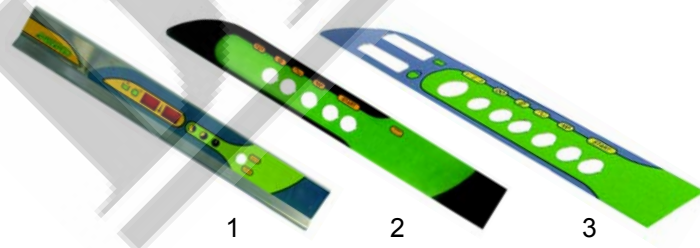

Fig.	Réf.	Description	Modèle	Réf. C.
1	508367	panneau de commande	GL4.32E	4244
2	508348	lexan	GL4.32EM	4776
3	508352	lexan	GL1040, GL1240	5042

### Electronique

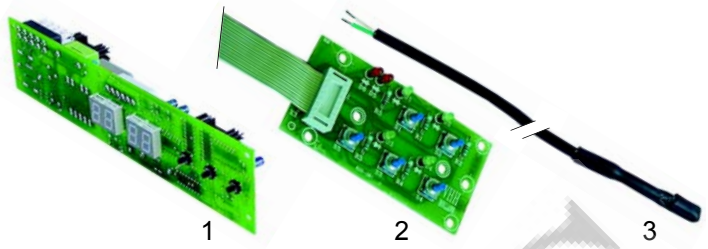

Fig.	Réf.	Description	Modèle	Réf. C.
1	400912	carte électronique	Project 28E, GL 4.32	4104
2	400613	carte électronique	AL 55.45E, AL 50.34E	4435 6478
3	379551	sonde température		4214, 4122, 4213

### Interrupteurs



Fig.	Réf.	Description	Modèle	Réf. C.
1	301164	interrupteur principal 0-3 (2-pôles)	Compact 20, Gemini CF/CR, Master 21,	364
2	301162	poussoir (2-pôles)	Minibar CF/CR, Program 25 CF/CR,	1146
3	301166	voyant 230V	Project 28, GL5.34, GL7.38, GL500, GL700	71

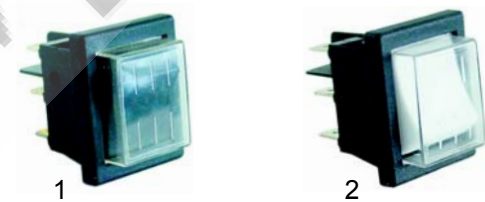

Fig.	Réf.	Description	Modèle	Réf. C.
1	301165	interrupteur (2-pôles)	Gemini CF/CR, Program 25CF/CR, Project 28, GL5.34, GL7.38, GL500, GL700, GL1040, GL1240	1
2	301163	poussoir (2-pôles um)	Master 21, Minibar CF/CR, Gemini CF/CR, Program 25CF/CR	2496

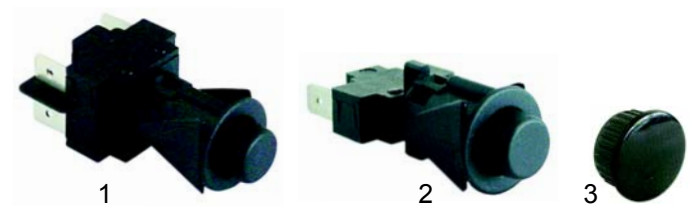

Fig.	Réf.	Description	Modèle	Réf. C.
1	301174	Schalter (2-pôles)	Passport 35.21/ 38.25/ 40.28/ 45.30/ 50.32/ 50.35/ 55.40/ 1040,	4042
2	301172	poussoir (1-pôles)	Master 22, Gemini CF/CR	4043
3	508358	capuchon Ø20mm		6224



Fig.	Réf.	Description	Modèle	Réf. C.
1	301175	interrupteur (2-pôles)	Program 25CF/CR, Project 28EM, GL4.32EM	4373
2	301173	poussoir (2-pôles um)	Aliseo 422, 428	4702



Fig.	Réf.	Description	Modèle	Réf. C.
1	359136	voyant 230V vert	Passport 35.21/ 38.25/ 40.28/	6207
2	359137	voyant 230V jaune	45.30/ 50.32/	6206
3	359134	voyant 230V transparent	50.35/ 55.40/ 1040	6204
4	n.m.l.	capot Ø9mm		6225



Fig.	Réf.	Description	Modèle	Réf. C.
1	359788	voyant 230V vert	Master 22,	4091
2	359789	voyant 230V jaune	Gemini CF/CR,	4090
3	359790	voyant 230V transparent	Program 25 CF/CR, GL4.32EM, GL1040, GL1240	4092
4	359791	voyant 230V vert	Compact 20, Gemini CF/CR, Program 25 CF/CR	1083

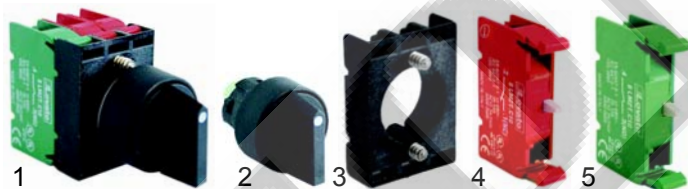

Fig.	Réf.	Description	Modèle	Réf. C.
1	301167	sélecteur de position complet		4452
2	301168	sélecteur de position 3 contact fermé		4453
3	301169	support pour paire de plots	Passport 55.40,	4449
4	301171	bloc contact 1 contact ouvert	GL1040,	4456
5	301170	bloc contact 1 contact fermé	GL1240	4450



Fig.	Réf.	Description	Modèle	Réf. C.
1	345810	micro-rupteur 1-pôle	Passport 35.21/ 38.25/ 40.28, Program 25 CF/CR, Master 21, Project 28E/EM (ancien), GL 5.34, GL 7.38	2651
2	345811	micro-rupteur 2-pôles	Passport 45.30/ 50.32/ 50.35/ 55.40, Master 22, Project 28E/EM, Aliseo 422, 428	4159
3	508360	écrou		897

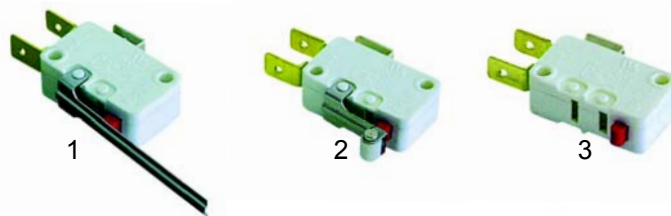

Fig.	Réf.	Description	Modèle	Réf. C.
1	345254	micro-rupteur 1-pôle	Passport 1040, GL1040, GL1240	2384
2	345041	micro-rupteur 1-pôle	Compact 20, Gemini CF/CR	925
3	345105	micro-rupteur 1-pôle	Compact 20 (ancien), Gemini CF/CR (ancien), Minibar CF/CR	1689



Fig.	Réf.	Description	Modèle	Réf. C.
1	345812	micro-rupteur 1-pôle	AL 55.E, AL 50.34E	6476

## Programmateurs

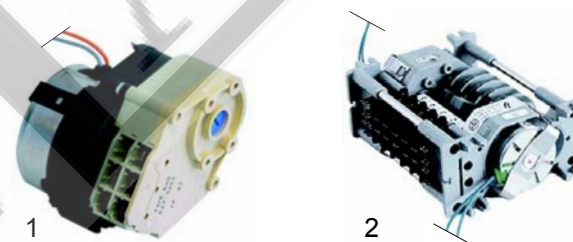

Fig.	Réf.	Description	Modèle	Réf. C.
1	360077	120° 2 cames	Compact 20, Gemini CF/CR, Master 21, Minibar CF/CR, Program 25 CF/CR, Project 28, GL500, GL700, GL4.32, GL 7.38, GL1040, GL1240, Passport 35.21/ 38.25/ 40.28/ 45.30/ 50.32/ 50.35/ 1040, Aliseo 422, 428	1623
2	360269	120°, 240°, 360° 5 cames	Passport 55.40	4781

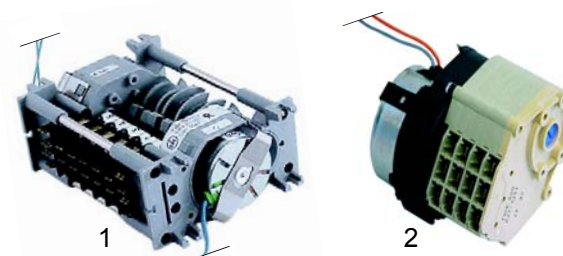

Fig.	Réf.	Description	Modèle	Réf. C.
1	360270	60°, 120°, 180°	GL1040, GL1240	5047
2	360268	18° régénération	universel	1144

## Pressostats



Fig.	Réf.	Plage d'enclenchement	Modèle	Réf. C.
1	541140	55/30	universel	35110
2	541142	123/75	AP1040, GL1040, GL1240, Aliseo 422, Aliseo 428	351

## Thermostats

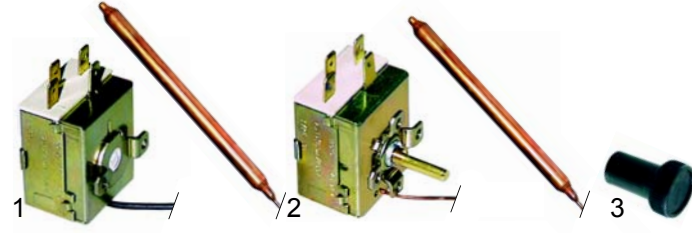

Fig.	Réf.	Description	Modèle	Réf. C.
1	390421	30°-90°C	universel	359
2	390006	30°-90°C	universel (ancien)	359
3	110906	manette	universel (ancien)	374



Fig.	Réf.	Description	Modèle	Réf. C.
1	390462	thermostat de sécurité 105°C surchauffeur	universel	4913
2	390461	thermostat de sécurité 95°C cuve	Projekt 28, GL4.32, AL 55.40, AL 55.45	4066

## Thermomètres



Fig.	Réf.	Description	Modèle	Réf. C.
1	541306	0-120°C/ 3000mm	AP 45.30, AP 50.30, AP 50.35, AP 55.40, AP1040, GL1040, GL1240	5576 5693

## Electrovannes

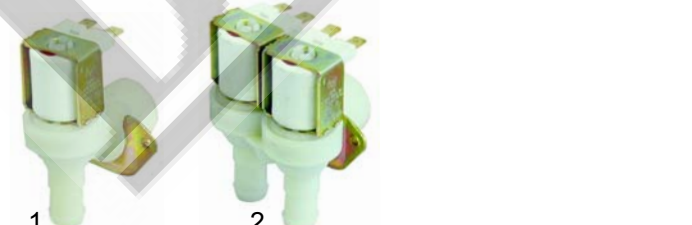

Fig.	Réf.	Description	Modèle	Réf. C.
1	370248	1 voie avec réduction	universel	394
2	370249	2 voies avec réduction	appareils avec kalter rinçage et Adoucisseur	148

## Relais - contacteur

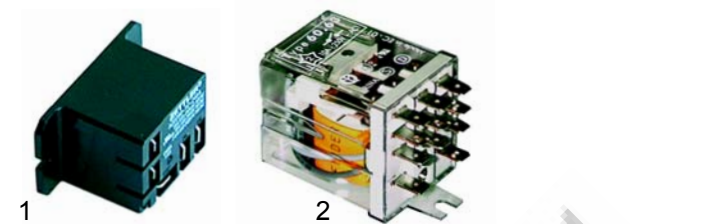

Fig.	Réf.	Description	Modèle	Réf. C.
1	380307	1-pôle contact inverseur 20A	Aliseo 422, 428	4867
2	380312	3-pôle contact inverseur 10A	GL1040, GL1240	2300



Fig.	Réf.	Description	Modèle	Réf. C.
1	380238	3 contact à fermeture + 1contact à fermeture AC1 20A	AP 35.21, AP 38.25, AP 40.28, AP 45.30, Project 28, GL4.32, GL 5.34, GL 7.38, Aliseo 422, 428	355
2	380213	3 contact à fermeture + 1contact à fermeture AC1 20A	AP 50.32, AP 50.35	5140
3	380204	3 contact à fermeture + 1contact à fermeture AC1 25A	AP 55.40, AP 10.40, GL 1040, GL 1240, AL 55.45, AL 50.34	4375

## Borniers

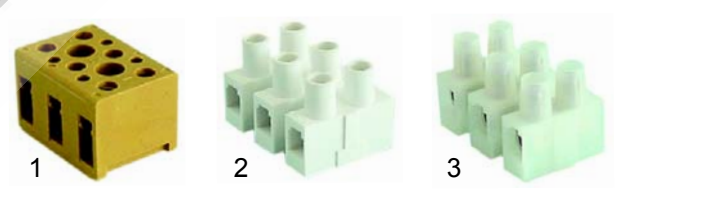

Fig.	Réf.	Description	Modèle	Réf. C.
1	508356	3-pôles 4mm <sup>2</sup>	Compact 20, Gemini, Program 25, Master 21, Mini-bar, Project	120
2	508353	3-pôles 4mm <sup>2</sup>	AP 35.21, AP 38.25, AP 40.28	921
3	508355	3-pôles 6mm <sup>2</sup>	AP 45.30, Master 22, Project 28, GL 4.32	4251



Fig.	Réf.	Description	Modèle	Réf. C.
1	508354	5-pôles 6mm <sup>2</sup>	AP 50.32, AP 50.35, AP 50.40, AP1040, GL1040, GL1240, Aliseo 422, 428, AL 55.45	891
2	550232	10-pôles 2,5mm <sup>2</sup>	AL 55.45	1488



## Filtres d'arrivée

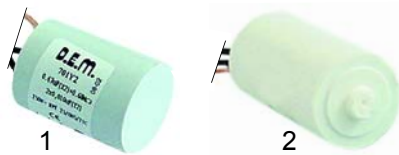

Fig.	Réf.	Description	Modèle	Réf. C.
1	365045	0,47µF (x2) + 0,68MΩ 2x0,01µF (y2)	universel	2779
2	365049		universel	5606

## Technique de dosage



Fig.	Réf.	Description	Modèle	Réf. C.
1	361370	doseur hydraulique pour produit	universel	60
2	361369	épurateur pompe doseuse 3L/h	universel	4880



Fig.	Réf.	Description	Modèle	Réf. C.
1	508123	té		2503
2	508116	raccord olive		2450
3	508326	clapet anti-retour		6535



Fig.	Réf.	Description	Modèle	Réf. C.
1	508301	raccord tétine doseur		5073
2	508306	raccord tétine doseur inox		5798

## Résistances

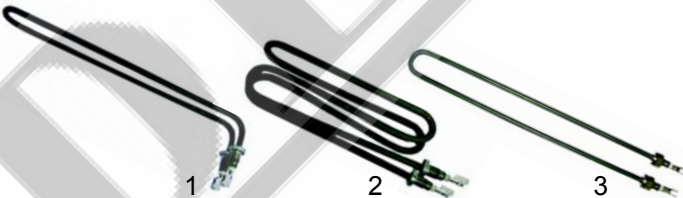

Fig.	Réf.	Description	Modèle	Réf. C.
1	416244	1000W/230V	Project 28, GL 4.32,	386
1	415145	1500W/230V	AP 50.32, AP 50.35, AP 1040, GL 1040, GL 1240	1350
1	416247	2000W/230V	AP 35.21, AP 38.25, AP 40.28, AP 45.30, AP 55.40, Project 28, GL 4.32	2114
2	415144	2000W/230V	Gemini, Program 25	312
3	415671	1500W/230V	AL 50.34, AL 50.40	200

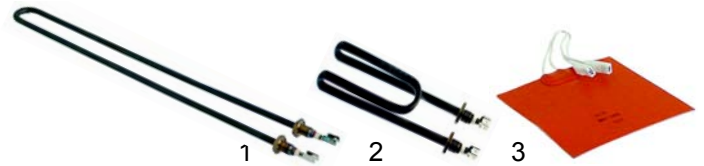

Fig.	Réf.	Description	Modèle	Réf. C.
1	416248	2000W/230V	AL 55.40	6445T
2	416246	1500W/230V	Project 28, GL 4.32	1595
3	416249	100W/230V	Aliseo 422	4761

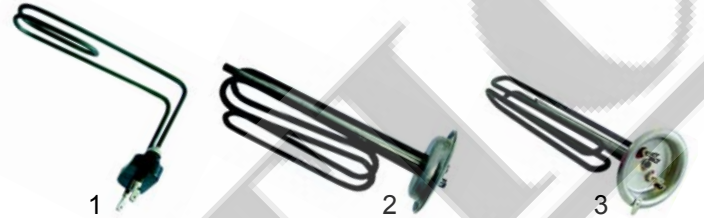

Fig.	Réf.	Description	Modèle	Réf. C.
1	415662	2000W/230V	Master 21	2836
2	415166	2000W/230V	AP 35.21, AP 38.25, AP 40.28, Compact 20, Master 22, Gemini, Program 25, Minibar	1324
2	415168	2500W/230V	Project 28, Minibar	1323
3	416245	3000W/230V	AP 45.30, GL 4.32	1294



Fig.	Réf.	Description	Modèle	Réf. C.
1	415146	4500W/230V	AP 50.32, AP 50.35, AP 50.34, AL 50.40, GL1040, GL1240, GL 500, GL 700, GL 5.34, GL 7.38	1299
2	415147	6000W/230V	GL 1040, GL1240	2126

## Accessoires résistances



Fig.	Réf.	Description	Modèle	Réf. C.
1	510418	joint torique	universel	679
2	520231	écrou M10x1	Master 21	267
3	508171	joint	universel	2750
4	521121	joint torique	universel	57
5	508080	flasque	universel	1871
6	550002	crochet avec vis	universel	1209

## A Surchauffeurs



Fig.	Réf.	Description	Modèle	Réf. C.
1	508221	surchauffeur 3 litres	Passport 35.21, 38.2-40.28	3161 2486
2	508067	surchauffeur	Gemini CF/CR, Program 25CF/CR	1699
3	508169	surchauffeur	Master 21	2745

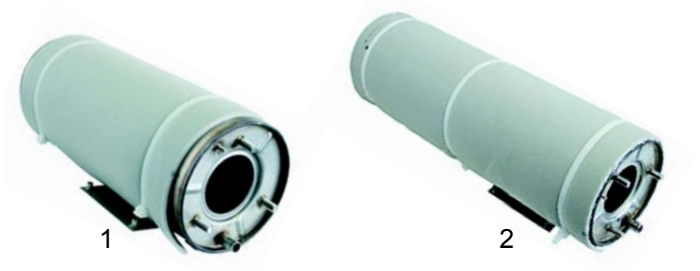

Fig.	Réf.	Description	Modèle	Réf. C.
1	508209	surchauffeur	Passport 45.30/ 50.32/ 50.35, GL4.32, AL 50.34, 50.40	2995
2	508281	surchauffeur 6,5 litres	Passport 55.40, AL 55.45	4839

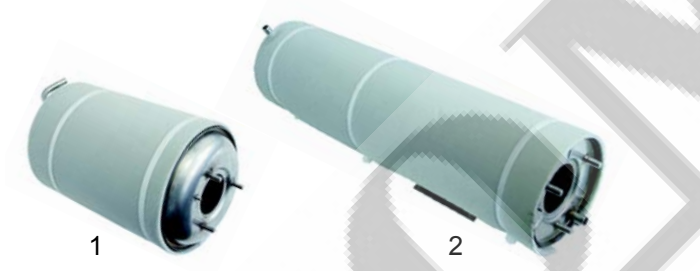

Fig.	Réf.	Description	Modèle	Réf. C.
1	508261	surchauffeur	Aliseo 422, Aliseo 428	4686
2	508283	surchauffeur 8 litres	Passport 1040, GL 1040, GL 1240	4889



Fig.	Réf.	Description	Modèle	Réf. C.
1	508088	raccord surchauffeur coude	Passport 55.40, Gemini CF/CR, Program 25 CF/CR, SELF 480. GL500, GL700	2128
2	508051	joint 12mm		1183
3	508052	raccord olive 3/8"		1184
4	508016	joint	Master 21	123
5	508149	embout de tuyau		2674

## Pompes

Pompes de vidange/ Electropompes rinçage

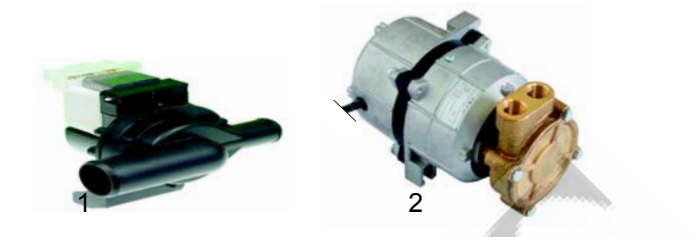

Fig.	Réf.	Description	Modèle	Réf. C.
1	500374	pompe de vidange 230V		379
2	500364	électropompe rinçage, 230V		380

## Pompes de lavage



Fig.	Réf.	Description	Modèle	Réf. C.
1	500365	0,10PS/ 230V	Compact 20, Passport 35.21, Master 21, 22, Minibar CF/CR	397
2	500366	0,25PS/ 230V	Gemini CF/CR, Passport 38.25/ 40.28, Program 25 CF/CR, Aliseo 422, 428	1629 4980
3	500372	0,5PS/ 230V	Passport 45.30/ 50.35, Project 28E, GL 4.32	10510 10511

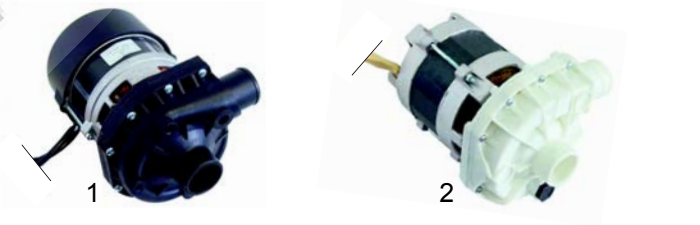

Fig.	Réf.	Description	Modèle	Réf. C.
1	500368	1PS/ 230V	AL 50.34E, GL 5.34 GL 7.38	2868
1	500367	1PS/ 400V	Passport 55.40	5688
2	500369	1PS/ 400V	Passport 1040	4054
2	500370	1PS/ 230V	Passport 1040, AL 5040, AL55.45	4053

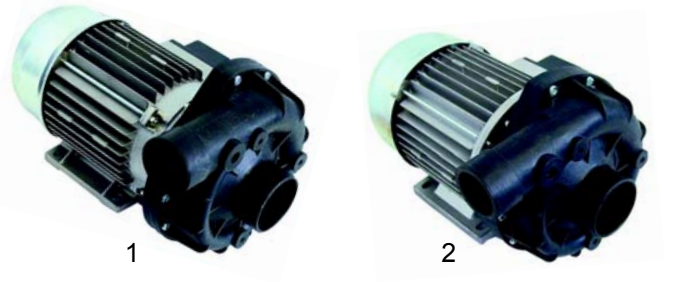

Fig.	Réf.	Description	Modèle	Réf. C.
1	500371	1,2PS/ 400V	GL1040, GL 1240	2532
2	500373	1,5PS/ 400V		424

**1**

**2**

**3**

**4**

**5**

Pompe		1 Turbine		2 Joint d'étanchéité		3 Joint de boîtier		4 Flasque de pompe		5 Condensateur	
Réf.	Réf. C.	Réf.	Réf. C.	Réf.	Réf. C.	Réf.	Réf. C.	Réf.	Réf. C.	Réf.	Réf. C.
500365	397	521226	4384	510692	4387	521704	4381	521521	4389	365012	
500366	1629	521233	4385	510693	4388	521728	4382	521529	4379	365015	
500367	5688	521235		510692		512709		521531		-	
500368	2868	509021	4406	510692	4387	521709	4383	521531	4380	365021	
500369	4054	521208		510692		521702		521506		-	
500370	4053	521211		510692		521702		521506		365021	
500371	2532	521231	4399	510693	4388	521711	4398	521532	4396	-	
500373	424	521264	4400	510693	4388	521711	4398	521561	4627		
500372	10511	510623	4386	510692	4387	521709	4384	521531	4626	365014	

## Notes

**DEOMATIC**

**DeoMatic Horeca-Industrie s.p.r.l.**

Pièces détachées pour Cuisines Industrielles

34 rue des alliés

Bongenotenstraat 34

1190 Bruxelles

1190 Brussel

Tel. : 02 343 97 64

Fax : 02 343 90 31

deomatic@skynet.be

www.deomatic.be

Partner of  **GEV GROUP**

Réf.: P090300301

